



UNI-ROYAL
厚聲集團

DATA SHEET

Product Name Anti-Sulfurized Automotive Thick Film Chip Resistors

Part Name NQ Series

Uniroyal Electronics Global Co., Ltd.

88#, Longteng Road, Economic & Technical Development Zone, Kunshan, Jiangsu, China

Tel +86 512 5763 1411 / 22 /33

Email marketing@uni-royal.cn

Manufacture Plant Uniroyal Electronics Industry Co., Ltd.

Aeon Technology Corporation

Royal Electronic Factory (Thailand) Co., Ltd.

Royal Technology (Thailand) Co., Ltd.

1. Scope

- 1.1 This datasheet is the characteristics of Anti-Sulfurized Automotive Thick Film Chip Resistors manufactured by UNI-ROYAL.
- 1.2 Excellent Anti-Sulfurized
- 1.3 AEC-Q200 qualified
- 1.4 Suitable for reflow & wave soldering
- 1.5 RoHS compliant

2. Part No. System

3. Part No. includes 14 codes shown as below:
4. 2.1 1st~4th codes: Part name. E.g.: NQ01, NQ02, NQ03, NQ05, NQ06, NQ07, NQ10, NQ12.
5. 2.2 5th~6th codes: Power rating.

E.g.: W=Normal Size "1~G" = "1~16"

Wattage	1/32	3/4	1/2	1/3	1/4	1/8	1/10	1/16	1/20	1
Normal Size	WH	07	W2	W3	W4	W8	WA	WG	WM	1W

If power rating is equal or lower than 1 watt, 5th code would be "W" and 6th code would be a number or letter.

E.g.: WA=1/10W W4=1/4W

- 2.3 7th code: Tolerance. E.g.: D=±0.5% F=±1% G=±2% J=±5% K=±10%
- 2.4 8th~11th codes: Resistance Value.
 - 2.4.1 If value belongs to standard value of E-24 series, the 8th code is zero, 9th~10th codes are the significant figures of resistance value, and the 11th code is the power of ten.
 - 2.4.2 If value belongs to standard value of E-96 series, the 8th~10th codes are the significant figures of resistance value, and the 11th code is the power of ten.
 - 2.4.3 11th codes listed as following:
 0=10⁰ 1=10¹ 2=10² 3=10³ 4=10⁴ 5=10⁵ 6=10⁶ J=10⁻¹ K=10⁻² L=10⁻³ M=10⁻⁴
- 2.5 12th~14th codes.
 - 2.5.1 12th code: Packaging Type. E.g.: C=Bulk T=Tape/Reel
 - 2.5.2 13th code: Standard Packing Quantity.
 4=4,000pcs 5=5,000pcs C=10,000pcs D=20,000pcs E=15,000pcs
 Chip Product: BD=B/B-20000pcs TC=T/R-10000pcs
 - 2.5.3 14th code: Special features.
 E = Environmental Protection, Lead Free, or Standard type.

3. Ordering Procedure

(Example: NS05 1/8W ±5% 10KΩ T/R-5000)

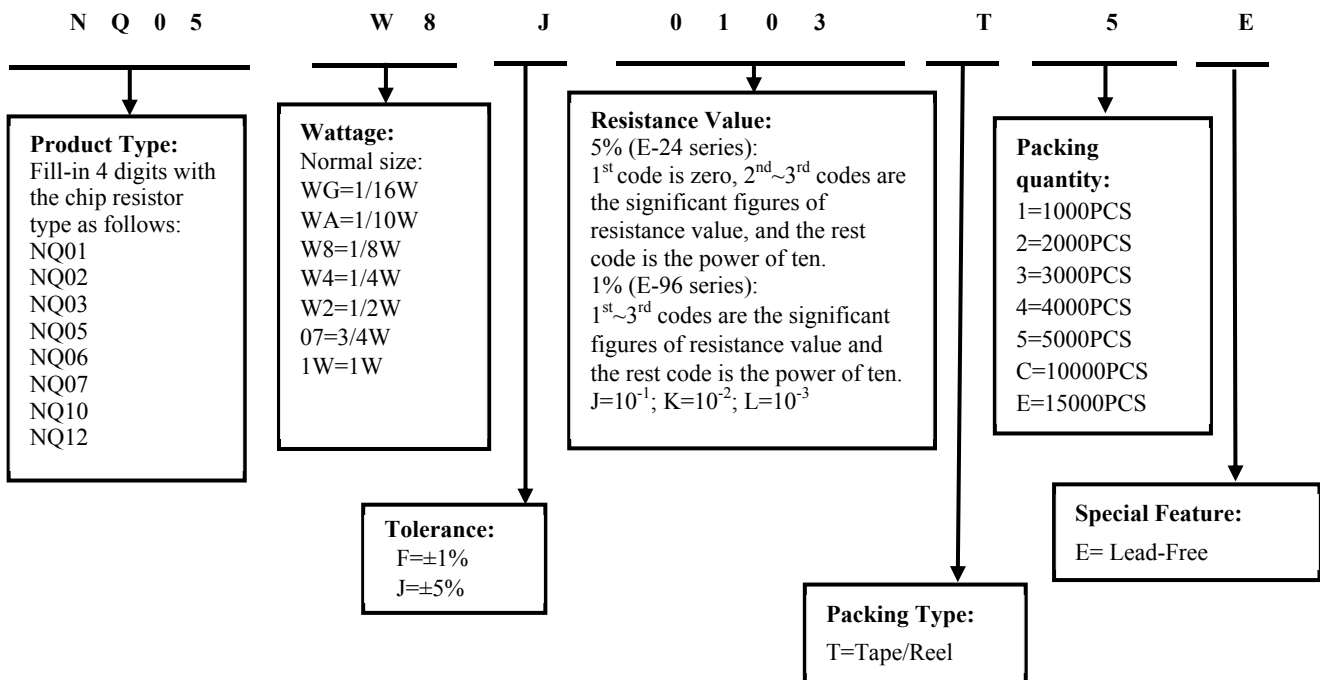

4. Marking

4.1 For NQ01, NQ02 size. Due to the very small size of the resistor's body, there is no marking on the body.



4.2 Normally, the making of 0Ω NQ03, 0Ω NQ05, 0Ω NQ06, 0Ω NQ07, 0Ω NQ10, 0Ω NQ12 resistors as following



0 → 0

4.3 ±5% tolerance products (E-24 series):

3 codes.

1st~2nd codes are the significant figures of resistance value, and the rest code is the power of ten.



333 → 33KΩ

4.4 ±1% tolerance products (E-96 series):

4 codes.

1st~3rd codes are the significant figures of resistance value, and the rest code is the power of ten.

Letter "R" in mark means decimal point.



2701 → 2.7KΩ

5. Dimension

Type	Dimension(mm)				
	L	W	H	A	B
NQ01(0201)	0.60±0.03	0.30±0.03	0.23±0.03	0.12±0.05	0.15±0.05
NQ02(0402)	1.00±0.10	0.50±0.05	0.35±0.05	0.20±0.10	0.25±0.10
NQ03(0603)	1.60±0.10	0.80±0.10	0.45±0.10	0.30±0.20	0.30±0.20
NQ05(0805)	2.00±0.15	1.25±0.15/-0.10	0.55±0.10	0.40±0.20	0.40±0.20
NQ06(1206)	3.10±0.15	1.55±0.15/-0.10	0.55±0.10	0.45±0.20	0.45±0.20
NQ07(1210)	3.10±0.10	2.60±0.20	0.55±0.10	0.50±0.25	0.50±0.20
NQ10(2010)	5.00±0.10	2.50±0.20	0.55±0.10	0.60±0.25	0.50±0.20
NQ12(2512)	6.35±0.10	3.20±0.20	0.55±0.10	0.60±0.25	0.50±0.20

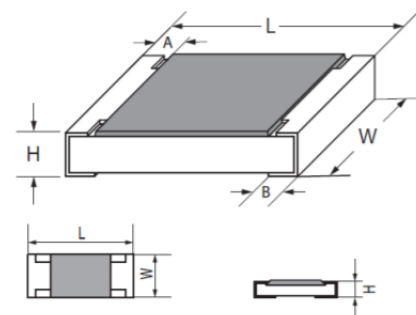

6. Resistance Range

Type	Power Rating at 70°C	Resistance Range	
		1%	5%
NQ01	1/20W	1Ω-10MΩ	1Ω-10MΩ
NQ02	1/16W	1Ω-10MΩ	1Ω-10MΩ
NQ03	1/10W	1Ω-10MΩ	1Ω-10MΩ
NQ05	1/8W	1Ω-10MΩ	1Ω-10MΩ
NQ06	1/4W	1Ω-10MΩ	1Ω-10MΩ
NQ07	1/2W	1Ω-10MΩ	1Ω-10MΩ
NQ10	3/4W	1Ω-10MΩ	1Ω-10MΩ
NQ12	1W	1Ω-10MΩ	1Ω-10MΩ

7. Ratings

Type	Max. Working Voltage	Max. Overload Voltage	Dielectric withstanding Voltage	Resistance Value of Jumper	Rated Current of Jumper	Max. Overload Current of Jumper	Operating Temperature
NQ01	25V	50V	/	<50mΩ	0.5A	1A	-55°C~155°C
NQ02	50V	100V	100V	<50mΩ	1A	2A	-55°C~155°C
NQ03	75V	150V	300V	<50mΩ	1A	2A	-55°C~155°C
NQ05	150V	300V	500V	<50mΩ	2A	5A	-55°C~155°C
NQ06	200V	400V	500V	<50mΩ	2A	10A	-55°C~155°C
NQ07	200V	500V	500V	<50mΩ	2A	10A	-55°C~155°C
NQ10	200V	500V	500V	<50mΩ	2A	10A	-55°C~155°C
NQ12	200V	500V	500V	<50mΩ	2A	10A </tr	

8. Soldering pad size recommended

Type	Dimension(mm)			
	A	B	C	D
NQ01	0.3±0.05	0.35±0.05	0.4±0.05	1.0±0.05
NQ02	0.50±0.05	0.45±0.05	0.5±0.05	1.4±0.05
NQ03	0.8±0.05	0.65±0.05	0.8±0.05	2.1±0.05
NQ05	1.0±0.1	1.0±0.1	1.3±0.1	3.0±0.1
NQ06	2.0±0.1	1.1±0.1	1.6±0.1	4.2±0.1
NQ07	2.0±0.1	1.1±0.1	2.6±0.1	4.2±0.1
NQ10	3.6±0.1	1.3±0.1	2.6±0.1	6.2±0.1
NQ12	4.9±0.1	1.6±0.1	3.3±0.1	8.1±0.1

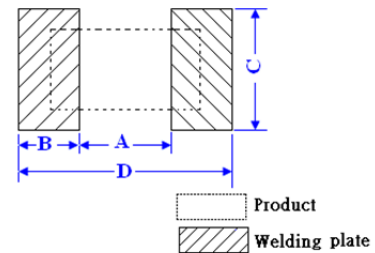

9. Derating Curve

Power rating will change based on continuous load at ambient temperature from -55 to 155°C. It is constant between -55 to 70°C, and derate to zero when temperature rise from 70 to 155°C.

Voltage rating:

Resistors shall have a rated direct-current (DC) continuous working voltage or an approximate sine-wave root-mean-square (RMS) alternating-current (AC) continuous working voltage at commercial-line frequency and waveform corresponding to the power rating, as determined from the following formula:

$$RCWV = \sqrt{P \times R}$$

Remark: RCWV: Rating Continuous Working Voltage (Volt.) P: power rating (Watt) R: nominal resistance (Ω)

In no case, the rated DC or RMS AC continuous working voltage must be greater than the applicable maximum value.

The overload voltage is 2.5 times RCWV or Max. Overload voltage whichever is lower.

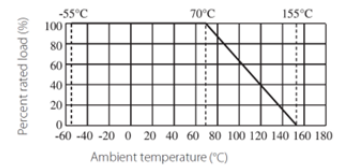

10. Structure



11. Performance Specification

Characteristic	Limits	Ref. Standards	Test Method
Operational life	±5%: ±(3.0%+0.1Ω) ±1%: ±(1.0%+0.1Ω)	MIL-STD-202	1,000 hours at 125°C, 36% power, derated voltage applied for 1.5 hours on, 0.5 hour off, Measurement at 24±4 hours after test conclusion.
	<100mΩ		Apply to rate current for 0 Ω
Electrical Characterization	NQ01: 1Ω≤R≤10Ω: -100~+350ppm/°C >10Ω: ±200ppm/°C NQ02-NQ12: 1Ω≤R≤10Ω: ±200ppm/°C >10Ω: ±100ppm/°C	User Spec	Parametrically test per lot and sample size requirements, summary to show Min, Max, Mean and Standard deviation at room as well as Min and Max operating temperatures.
Short-time overload	±1%: ±(1.0%+0.05Ω) ±5%: ±(2.0%+0.05Ω)	JIS-C-5201	4.13 Permanent resistance change after the application of a potential of 2.5 times RCWV or Max. Overload Voltage whichever less for 5 seconds..
	<50mΩ		Apply max Overload current for 0Ω
External Visual	No Mechanical Damage	MIL-STD-883 Method 2009	Electrical test not required. Inspect device construction, marking and workmanship
Physical Dimension	Reference 5. Dimension Standards	JESD22 MH Method JB-100	Verify physical dimensions to the applicable device detail specification. Note: User(s) and Suppliers spec. Electrical test not required.
Resistance to Solvent	Marking Unsmearred	MIL-STD-202 Method 215	Note: Add Aqueous wash chemical – OKEM Clean or equivalent. Do not use banned solvents.
Terminal Strength	Not broken	JIS-C-6429	Force of 1.8kg for 60 seconds.
High Temperature Exposure (Storage)	±(1.0%+0.05Ω)	MIL-STD-202 Method 108	1000hrs. @T=155°C. Unpowered. Measurement at 24±2 hours after test conclusion.
	<50mΩ		Apply to rate current for 0 Ω
Temperature Cycling	±(1.0%+0.05Ω)	JESD22 Method JA-104	1000 Cycles (-55°C to +155°C). Measurement at 24±2 hours after test conclusion.
	<50mΩ		Apply to rate current for 0 Ω
Biased Humidity	±5%: ±(3.0%+0.1Ω) ±1%: ±(1.0%+0.1Ω)	MIL-STD-202 Method 103	1000 hours 85°C, 85%RH. Note: Specified conditions: 10% of operating power. Measurement at 24±2 hours after test conclusion.
	<100mΩ		Apply to rate current for 0 Ω
Mechanical Shock	±(1.0%+0.05Ω)	MIL-STD-202 Method 213	Wave Form: Tolerance for half sine shock pulse. Peak value is 100g's. Normal duration (D) is 6ms, velocity 12.3ft/s 100Hz.
Vibration	±(1.0%+0.05Ω)	MIL-STD-202 Method 204	5g's for 20 min., 12cycle each of 3 orientations. Note: Use 8''*5''PCB. 031'' thick 7 secure points on one long side and 2 secure points at corners of opposite sides. Parts mounted within 2' from any secure point. Test from 10-2000Hz.
ESD	±(1.0%+0.05Ω)	AEC-Q200-002	With the electrometer in direct contact with the discharge tip, verify the voltage setting at levels of ±500V, ±1KV, ±2KV, ±4KV, ±8KV, The electrometer reading shall be within ±10% for voltages from 500V to ≤ 800V.
Solderability	95% coverage Min.	J-STD-002	For both leaded & SMD. Electrical test not required. Magnification 50X. Conditions: a) Method B 4hrs at 155°C dry heat, the dip in bath with 245°C, 5s. b) Method D: at 260°C, 60s.

Flammability	No ignition of the tissue paper or scorching or the pinewood board	UL-94	V-0 or V-1 are acceptable. Electrical test not required.
Board Flex	$\pm(1.0\%+0.05\Omega)$	JIS-C-6429	Bending 3mm(NQ01-NQ05)/2mm(NQ06-NQ12)for 60±5sec
	<50mΩ		Apply to rate current for 0 Ω
Flame Retardance	No flame	AEC-Q200-001	Temperature sensing at 500°C, Voltage power subjected to 32VDC current clamped up to 500VDC and decreased in 1.0VDC/hour.
Resistance to Soldering Heat	$\pm(1.0\%+0.05\Omega)$	MIL-STD-202 Method 210	Condition B No per-heat of samples. Note: Single Wave Solder-Procedure 2 for SMD and Procedure 1 for Leaded with solder within 1.5mm of device body.
	<50mΩ		Apply to rate current for 0 Ω
Sulfuration test	$\pm(1.0\%+0.05\Omega)$	ASTM B-809-95	sulfur(saturated vapor) , Temperature: 50±2°C Humidity: 86 ~ 90%RH, 1000H .
	$\pm(5.0\%+0.05\Omega)$	/	Soaked in industrial oil with sulfur substance 3.5% contained 105°C ±3°C 500H

12. Packing

12.1 Dimension of Paper Taping :(Unit: mm)

Type	A	B	C ±0.05	$\Phi D_{-0}^{+0.1}$	E ±0.1	F ±0.05	G ±0.1	W ±0.2	T
NQ01	0.40±0.05	0.70±0.05	2.00	1.50	1.75	3.50	4.00	8.00	0.42±0.10
NQ02	0.65 ±0.10	1.20±0.1	2.00	1.50	1.75	3.50	4.00	8.00	0.42±0.05

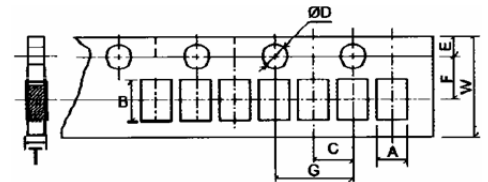

Type	A ±0.2	B ±0.2	C ±0.05	$\Phi D_{-0}^{+0.1}$	E ±0.1	F ±0.05	G ±0.1	W ±0.2	T ±0.1
NQ03	1.10	1.90	2.0	1.5	1.75	3.5	4.0	8.0	0.67
NQ05	1.65	2.40	2.0	1.5	1.75	3.5	4.0	8.0	0.81
NQ06	2.00	3.60	2.0	1.5	1.75	3.5	4.0	8.0	0.81
NQ07	2.80	3.50	2.0	1.5	1.75	3.5	4.0	8.0	0.75

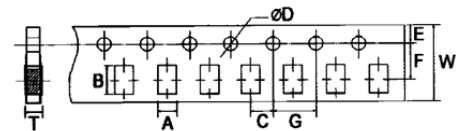

12.2 Dimension of plastic taping: (Unit: mm)

Type	A ±0.2	B ±0.2	C ±0.05	$\Phi D_{-0}^{+0.1}$	$\Phi D1_{-0}^{+0.25}$	E ±0.1	F ±0.05	G ±0.1	W ±0.2	T ±0.1
NQ10	2.90	5.60	2.00	1.50	1.50	1.75	5.50	4.00	12.00	1.00
NQ12	3.50	6.70	2.00	1.50	1.50	1.75	5.50	4.00	12.00	1.00

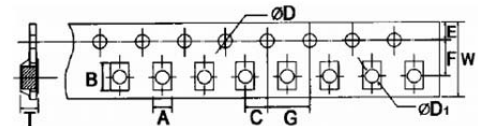

12.3 Dimension of Reel : (Unit: mm)

Type	Taping	Qty/Reel	A ±0.5	B ±0.5	C ±0.5	D ±1	M ±2	W ±1
NQ01	Paper	15,000pcs	2.0	13.0	21.0	60.0	178	10
NQ02	Paper	10,000pcs	2.0	13.0	21.0	60.0	178	10
NQ03	Paper	5,000pcs	2.0	13.0	21.0	60.0	178	10
NQ05	Paper	5,000pcs	2.0	13.0	21.0	60.0	178	10
NQ06	Paper	5,000pcs	2.0	13.0	21.0	60.0	178	10
NQ07	Paper	5,000pcs	2.0	13.0	21.0	60.0	178	10
NQ10	Embossed	4,000pcs	2.0	13.0	21.0	60.0	178	13.8
NQ12	Embossed	4,000pcs	2.0	13.0	21.0	60.0	178	13.8

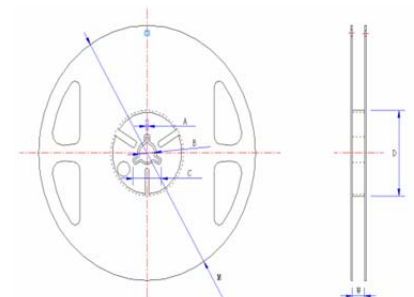

13. Note

- 13.1. UNI-ROYAL recommend products store in warehouse with temperature between 15 to 35°C under humidity between 25 to 75%RH.
 Even under storage conditions recommended above, solder ability of products will be degraded stored over 1 year old.
- 13.2. Cartons must be placed in correct direction which indicated on carton, otherwise the reel or wire will be deformed.
- 13.3. Storage conditions as below are inappropriate:
- a. Stored in high electrostatic environment
 - b. Stored in direct sunshine, rain, snow or condensation.

14. Record

Version	Description	Page	Date	Amended by	Checked by
1	First version	1~8	Mar.20, 2018	Haiyan Chen	Nana Chen
2	1. Modify the product structure diagram 2.Modify NQ01 packing quantity	5 8	Jun.06, 2018	Haiyan Chen	Nana Chen
3	Modify product name	1~8	Dec.17, 2018	Haiyan Chen	Nana Chen
4	Modify characteristic	5~6	Feb.16, 2019	Haiyan Chen	Yuhua Xu
5	Experimental method and standard for adding vulcanization	6	Mar.04, 2019	Haiyan Chen	Yuhua Xu

© Uniroyal Electronics Global Co., Ltd. All rights reserved. Specification herein will be changed at any time without prior notice